



USB Camera

WAT-01U2



Operation Manual

This Operation Manual covers safety, camera functions, installation and the correct operating procedure for the WAT-01U2. First, we ask you to read this Operation Manual thoroughly, then install and operate the WAT-01U2 as advised. In addition, for future reference, we also advise safekeeping of this manual.

Please contact the distributor or dealer from which the WAT-01U2 was purchased, if you do not understand the installation, operation or safety instructions laid out in this manual. Not understanding the contents of the Operation Manual sufficiently may cause damage to the camera.



Guide to the Safety Symbols

The definitions of the symbols used in this operation manual are:

-  When you do not adhere to or take notice of the "Danger" sign, it may lead to a serious accident such as death or injury caused by fire or electric shock.
-  When you do not adhere to or take notice of the "Warning" sign, it may cause severe damage such as a physical injury.
-  When you do not adhere to or take notice of the "Caution" sign, it may incur injury and cause damage to peripheral objects in the immediate surroundings.

Cautions for Safety

The WAT-01U2 is designed to be used safely; however, if not used safely, it may lead to a physical accident caused by fire and electric shock. Therefore, please keep and read the "Cautions for safety" below for protection against accidents.

- 
 - Do not disassemble and/or modify the WAT-01U2.
 - Do not operate the WAT-01U2 with wet hands.
- 
 - Do not expose the WAT-01U2 to wetness or high moisture conditions.
The WAT-01U2 is designed and approved for indoor use only. The WAT-01U2 is not water-resistant or waterproof. If the location of the camera is outdoors or in an outdoor like environment, we recommend that you use an outdoor camera housing.
 - Protect the WAT-01U2 from condensation.
Keep the WAT-01U2 dry at all times during storage and operation.
 - Should the camera not work properly, switch off the power immediately. Then check the camera according to the "Problems and Trouble shooting" section.

- 
 - Avoid the striking of hard objects or dropping the WAT-01U2.
The WAT-01U2 uses high quality electrical parts and precision components.
 - Do not connect any power supply directly to the video out terminal of the unit.
Do not connect the WAT-01U2 with any monitor using a video/power single transmission terminal. The WAT-01U2 is not designed for use with this type of equipment. We also advise you to read the operation manual of the monitor you plan to use before any connections are made.
 - Do not install the WAT-01U2 in a position subject to direct sunlight.
Sunlight shinning directly onto the WAT-01U2 lens can cause damage to the sensor.
 - Select a stable place for installation of the WAT-01U2.
Use a support of durable strength around an installation position on a ceiling or wall when a camera stand or tripod is used.
 - Do not move the WAT-01U2 with the cables connected. Before moving the WAT-01U2, always remove the cable from the camera first.
 - Avoid using the WAT-01U2 near any strong electro-magnetic field.
After installing into main equipment, if the WAT-01U2 is exposed to electromagnetic waves causing the monitored image to become distorted, we recommend the camera be shielded by appropriate protective casing.

Problems and Trouble Shooting

If any of the following problems occur when using the WAT-01U2,

- An optimal picture cannot be obtained, after checking that all the cables and connections are correctly in place.
- Smoke or any unusual odor emerges from the WAT-01U2.
- An object becomes embedded or a quantity of liquid seeps into the camera housing.
- More than the recommended voltage or/and amperage has been applied to the WAT-01U2 by mistake.
- Anything unusual occurring to any equipment connected to the WAT-01U2.

Disconnect the camera immediately according to the following procedures:

- ① Switch off the main power supply to the camera.
- ② Remove the cables connected to the WAT-01U2.
- ③ Contact the distributor or dealer from which the WAT-01U2 was purchased.

About EMC

The WAT-01U2 is in conformity with EMC test standards carried out by authorized organizations in Japan.

- FCC Part15
- EN55032 / EN55024

FCC Notice "Declaration of Conformity Information"

This equipment has been tested and found to comply with the limits for a Class B digital device, pursuant to part 15 of the FCC Rules. These limits are designed to provide reasonable protection against harmful interference in a residential installation. This equipment generated, uses and can radiate radio frequency energy and, if not installed and used in accordance with the instructions, may cause harmful interference to radio communications. However, there is no guarantee that interference will not occur in a particular installation. If this equipment does cause harmful interference to radio or television reception, which can be determined by turning the equipment off and on, the user is encouraged to try to correct the interference by one or more of the following measures:

- Reorient or relocate the receiving antenna.
- Increase the separation between the equipment and receiver.
- Connect the equipment into an outlet on a circuit different from that to which the receiver is connected.
- Consult the dealer or an experienced radio/TV technician for help.

Caution:

- Do not modify the camera. A modified camera may not conform to EMC standards.
- Compatibility of EMC will have tested using the accessories and optional accessories.

Contents

Using the contents figures below, make sure all parts are present before use.

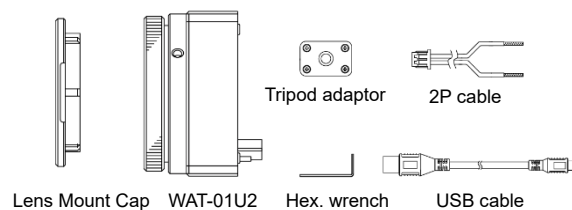

Description of Parts

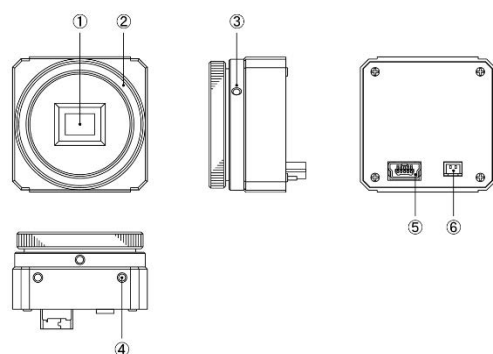

- ① IMAGE SENSOR FRONT FACE
The light receiving face of the image sensor (Dirt, water or oil deposits on the image sensor will cause an unclear picture on the monitor. Attach the lens cap to protect the lens and the sensor from contamination and damage.)
- ② LENS MOUNT
Mount for the lens (CS-mount)
- ③ FINE FOCUS ADJUSTMENT SCREWS
There are 3 hex. adjustment screws each placed at intervals of 120° for fine focusing of the lens.
- ④ MOUNTING FEATURES
Two mounting holes for M2 fasteners located on each of the top and bottom surfaces.
- ⑤ USB mini-B CONNECTOR
For USB connection.
- ⑥ GPIO CONNECTOR
General Purpose Input/Output connector. (Please refer to the User's Manual)

Set-up and Operation

- 1) Ensure that the power to the WAT-01U2 and the peripheral equipment is turned off before making any connections.
- 2) Remove the lens mount cap from the WAT-01U2 and attach the CS-mount lens. Use the optional C-mount adaptor (30CMA-R) when a C-mount lens is used.
- 3) Connect WAT-01U2 with the PC, using an attached cable.
- 4) Start the software application and adjust the lens while viewing the image displayed. If further focus adjustment is required, use the hex wrench (included) and loosen the ③FINE FOCUS ADJUSTMENT SCREWS and rotate the lens to adjust the focus. After completion of adjustment, please make sure that the screws are securely fastened.

About tripod adaptor

If using the mounting bracket (included), please refer to the figure below and secure the bracket to the camera using the M2x6mm screws (included).

<Adaptor Installation Example>

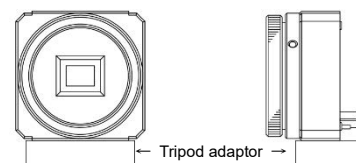

Options

To purchase these options, please contact the distributor or dealer from which you purchased the WAT-01U2.



C-mount Adaptor (30CMA-R)

This lens mount adaptor is used to convert a CS-mount to a C-mount.



Holder (H003)

USB cable fixer for WAT-01U2.



Mini Stand (MS50)

A convenient stand for the WAT-01U2. With this stand, the camera can be adjusted to any desired angle.

Contact information

- Design and specifications are subject to change without notice.
- Watec is not responsible for any inconvenience or the attendant damages to the video and monitoring recording equipment caused by misuse, mis-operation or improper wiring of our equipment.
- If for any reason the WAT-01U2 does not work properly, or if you have any questions regarding installation or operation, please contact the distributor or dealer from which it was purchased.

Contact information

 **Watec Co., Ltd.**

Add.: 254-2 Nihonkoku, Daihoji, Tsuruoka- Shi,
 Yamagata-Ken, 997-0017 Japan
 TEL: +81-235-23-4400 FAX: +81-235-23-4409
 Email: info-o@watec.co.jp
 URL: http://www.watec.co.jp

5010Z00-Y2000005