



CCD Camera with External Synchronization Function

WAT-525EX2/535EX2

Operation Manual

This Operation Manual covers safety, camera functions, installation and the correct operating procedure for the WAT-525EX2/535EX2. First, we ask you to read this Operation Manual thoroughly, then install and operate the WAT-525EX2/535EX2 as advised. In addition, for future reference, we also advise safekeeping of this manual.

Please contact the distributor or dealer from which the WAT-525EX2/535EX2 was purchased, if you do not understand the installation, operation or safety instructions laid out in this manual. Not understanding the contents of the Operation Manual sufficiently may cause damage to the camera.

Guide to the Safety Symbols

The definitions of the symbols used in this operation manual are:

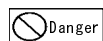

When you do not adhere to or take notice of the "Danger" sign, it may lead to a serious accident such as death or injury caused by fire or electric shock.

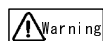

When you do not adhere to or take notice of the "Warning" sign, it may cause severe damage such as a physical injury.

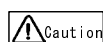

When you do not adhere to or take notice of the "Caution" sign, it may incur injury and cause damage to peripheral objects in the immediate surroundings.

Cautions for Safety

The WAT-525EX2/535EX2 is designed to be used safely; however, it may lead to a physical accident caused by fire and electric shock if not used correctly. Therefore, please keep and read the "Cautions for safety" for protection against accidents.

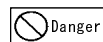

- Do not disassemble and/or modify the WAT-525EX2/535EX2.
- Do not operate the WAT-525EX/535EX with wet hands.



- Use a stabilized power adaptor designed for DC+12V±10%, with a current capacity of more than 250mA for the WAT-525EX2/535EX2.

The recommended voltage is DC+12V±10%

- Do not expose the WAT-525EX2/535EX2 to wetness or high moisture conditions.

The WAT-525EX2/535EX2 is designed and approved for indoor use only. The WAT-525EX2/535EX2 is not water-resistant or waterproof. If the location of the camera is outdoors or in an outdoor like environment, we recommend that you use an outdoor camera housing.

- Protect the WAT-525EX2/535EX2 from condensation. Keep the WAT-525EX2/535EX2 dry at all times during storage and operation.
- Should the camera not work properly, switch off the power immediately. Then check the camera according to the "Problems and Trouble shooting" section.

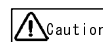

- Avoid the striking of hard objects or dropping the WAT-525EX2/535EX2.

The WAT-525EX2/535EX2 uses high quality electrical parts and precision components.

- Do not connect any power supply directly to the video out terminal of the unit.

Do not connect the WAT-525EX2/535EX2 with any monitor using a video/power single transmission terminal. The WAT-525EX2/535EX2 is not designed for use with this type of equipment. We also advise you to read the operation manual of the monitor you plan to use before any connections are made.

- Do not install the WAT-525EX2/535EX2 in a position subject to direct sunlight.

Sunlight shining directly onto the WAT-525EX2/535EX2 lens can cause damage to the CCD.

- Select a stable place for installation of the WAT-525EX2/535EX2.

Use a support of durable strength around an installation position on a ceiling or wall when a camera stand or tripod is used.

- Do not move the WAT-525EX2/535EX2 with the cables connected.

Before moving the WAT-525EX2/535EX2, always remove the video cable and power cable from the rear of the camera first.

- Avoid using the WAT-525EX2/535EX2 near any strong electromagnetic field.

Avoid emission sources of electromagnetic waves when the WAT-525EX2/535EX2 is installed into main equipment.

Problems and Trouble Shooting

If any of the following problems occur when using the WAT-525EX2/535EX2,

- An optimal picture cannot be obtained, after checking that all the cables and connections are correctly in place
- Smoke or any unusual odor emerges from the WAT-525EX2/535EX2
- An object becomes embedded or a quantity of liquid seeps into the camera housing
- More than the recommended voltage or/and amperage has been applied to the WAT-525EX2/535EX2 by mistake
- Anything unusual occurring to any equipment connected to the WAT-525EX2/535EX2

Disconnect the camera immediately according to the following procedures:

- Switch off the main power supply to the camera.
- Remove the power and video cables connected to the WAT-525EX2/535EX2.
- Contact the distributor or dealer from which the WAT-525EX2/535EX2 was purchased.

About EMC

The WAT-525EX2/535EX2 is in conformity with EMC test standards carried out by authorized organizations in Japan.

E I A FCC Part15 class B
CCIR EN61000-6-3/EN50130-4

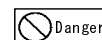

Do not modify the WAT-525EX2/535EX2. A modified camera will not conform to EMC test standards.

Contents

Using the contents figures below, check to make sure all parts are present before use.

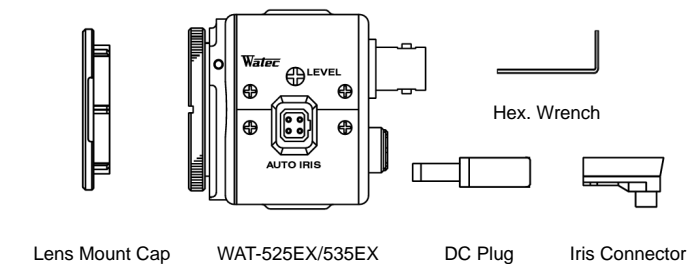

Description of Parts

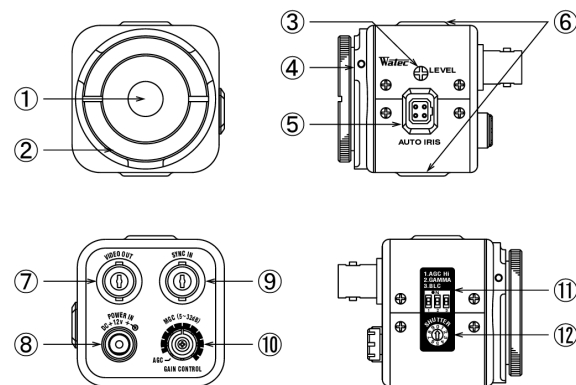

① CCD FRONT FACE

- The light receiving face of the CCD camera (Dirt, water or oil deposits on the CCD will cause an unclear picture on the monitor. Attach the lens cap to protect the lens and/or the CCD from contamination and damage.)

② LENS MOUNT

- Mount for the lens (CS-mount)

③ IRIS LEVEL VOLUME

- By controlling the volume, the iris level of the DC iris lens can be adjusted.

④ FOCUSING ADJUSTMENT SCREWS

- There are 3 hex. adjustment screws each placed at intervals of 120° for fine focusing of the lens.

⑤ AUTO-IRIS SOCKET

- This socket is for the video/DC auto-iris lens cable connector. (Video/DC auto-select)

⑥ TRIPOD MOUNTING SCREW HOLES

- Mounting holes for stands. The size of these threads is 1/4", 20 threads, 4.5±0.2mm, which is the same as any standard camera tripods (U1/4").

⑦ VIDEO OUT (BNC)

- The terminal for composite video signal output

⑧ POWER IN

- The terminal designed for connection with the DC-plug of the power adaptor

⑨ SYNC IN

- BNC terminal for the external synchronization signal input

⑩ GAIN CONTROL

- Gain volume level adjustment

⑪ FUNCTION SWITCHES

- Functional switches for setting gamma control, AGC and BLC(Back light compensation).

⑫ AE MODE CONTROL

- The dial for the electronic shutter mode control according to the object being monitored.

Power Supply

Use a stabilized power adaptor designed for DC+12V±10%, with a current capacity of more than 250mA. Use the optional DC plug if the shape or polarity of the DC plug of the power adaptor to be used is not compatible with the camera (See the drawing on the right below).

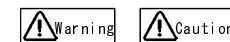

The wiring on the connector must be exact. Be careful not to touch the other terminal while wiring. Protect the wiring portion by using insulation tape after wiring. If the above care and attention is not adhered to, damage to the WAT-525EX2/535EX2 and power adaptor may occur and may also cause fire.

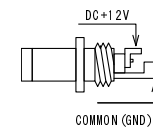

Auto-iris Lens

Before connecting the auto-iris lens, please make sure that the pin configuration is correct by confirming with the following table. If the configuration of your iris connector is different from the following, the plug and pins will need to be rewired.

Pin No.	EIAJ Video Auto-iris Lens Arrangement	EIAJ DC Auto-iris Lens Arrangement
①	Power	Control -
②	Not used	Control +
③	Iris signals	Drive +
④	Common (GND)	Drive -

Set-up and Operation

- Ensure that the power to the WAT-525EX2/535EX2 and the peripheral equipment is turned off before making any connections.
- Remove the lens mount cap from the WAT-525EX2/535EX2 and attach the CS-mount lens. Use the optional C-mount adaptor(34CMA-R) when a C-mount lens is used.
- Connect the iris control cable to ⑤AUTO-IRIS SOCKET on the WAT-525EX2/535EX2 when an auto-iris lens is being used.

- Connect ⑦VIDEO OUT on the WAT-525EX2/535EX2 with the monitor, using a coaxial cable with 75Ω impedance, such as an RG-59 or an RG-6/U. Select a monitor with the same television system as the WAT-525EX2/535EX2: EIA or CCIR. A monitor with more than 600TV lines is recommended.

- Insert the power plug of the power adaptor to ⑧POWER IN on the back panel of the WAT-525EX2/535EX2. Confirm that the power adaptor is not connected before insertion of the power plug into ⑧POWER IN.

- Turn on the power to the WAT-525EX2/535EX2, the monitor and all other allied equipment. When a picture cannot be obtained on the monitor, or a problem occurs, check and follow the procedure mentioned in the [Problems and Trouble Shooting] section.

- After following the procedure below and the picture is still out of focus, open the iris fully and loosen ④FOCUSING ADJUSTMENT SCREWS with the hex. wrench and move the lens forwards until a clear picture is obtained.

Manual Lens	Adjust the focus and iris to the best position.
Video Auto-iris Lens	Adjust the focus on the lens.
DC Auto-iris Lens	Adjust the iris level, then focus. See below.

Iris Level Adjustment (for DC auto-iris lenses only)

Adjust ③IRIS LEVEL VOLUME placed on the side of the unit until the object comes to be optimally bright. No change will occur if a video iris lens or manual iris lens is fitted.

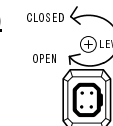

- Remove the camera casing and select any required shutter speed by the ⑫AE MODE CONTROL to one of its 10 positions. (Shutter mode is set to 9 (OFF) upon shipment.)

No.	Mode	Shutter Speeds (Sec.)	
		EIA	CCIR
0	FL	1/100	1/120
1	ES	1/250	
2	ES	1/500	
3	ES	1/1000	
4	ES	1/2000	
5	ES	1/5000	
6	ES	1/10000	
7	ES	1/100000	
8	EI	1/60-1/100000	1/50-1/100000
9	OFF	1/60	1/50

Mode	Effect
FL	Reduces the flickering phenomena occurring on the monitor screen caused by fluorescent or mercury lamps.
ES	Fixes the shutter speed in a range between 1/250-1/100000. (7steps)
EI	Automatically selects the shutter speed in the range between EIA: 1/60-1/100000, CCIR: 1/50-1/100000 according to the lighting condition.
OFF	Fixes the shutter speed to EIA: 1/60, CCIR: 1/50.

※In EI mode, intense light may leave a trail on the screen longitude. This smearing is a natural phenomenon and is not due to equipment failure or fault.

- Set the ⑪FUNCTION SWITCHES according to your requirements.

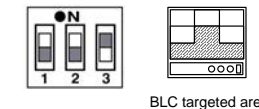

Switch	Setting	Effective Condition (Example)	Upon Shipment
1. AGC	ON [HI]	When minimum illumination is more important than the S/N ratio (Surveillance in a low light environment)	✓
	OFF [LO]	When a clear picture is required in standard lighting conditions	
2. Gamma correction	ON	Applicable to a general surveillance monitoring system	✓
	OFF	When gamma correction is not required for image processing	
3. BLC	ON	When the picture of the monitored object is silhouetted due to strong lighting from above or behind	
	OFF	When the illumination differences between a monitored object is narrow	✓

※BLC is available when ⑫AE MODE CONTROL is set to position 8(EI) or when auto-iris lens is used.

10) Set the gain control to any required environment.

For AGC, turn the AGC control anti-clockwise to the locking position. AGC automatically adjusts to a range between 5 to 32dB(HI)/5 to 20dB(LO).

With MGC, gain is manually adjusted in a range between 5 to 32dB. In a low light environment, when illumination of the object is important, increase the manual gain. Lower the gain control for a clearer picture with less noise.



11) When the external sync. function is required, input the composite video or the composite sync. signal to @SYNC IN. The range of the level for composite sync. is 0.2 to 5.0V(p-p). The camera has a resistance of 10kΩ. When more than 75Ω termination is required for impedance matching, add the additional Ωs to the external sync. signal line.

Options

To purchase these options, please contact the distributor or dealer from which you purchased the WAT-525EX2/535EX2.



C-mount Adaptor (34CMA-R)

This lens mount adaptor is used to convert a CS-mount to a C-mount.



Mini Stand (MS50)

A convenient stand for the WAT-525EX2/535EX2. With this stand, the camera can be adjusted to any desired angle.



Bracket (B003)

This bracket is effective for a stable installation of the WAT-525EX2/535EX2.

Specifications

WAT-525EX2

Model	WAT-525EX2 (EIA)	WAT-525EX2 (CCIR)
Pick-up Element	1/2 inch interline transfer CCD image sensor	
Unit Cell Size	8.4 μm(H) × 9.8 μm(V)	8.6 μm(H) × 8.3 μm(V)
Minimum Illumination	0.002 lx. F1.4	

WAT-535EX2

Model	WAT-535EX2 (EIA)	WAT-535EX2 (CCIR)
Pick-up Element	1/3 inch interline transfer CCD image sensor	
Unit Cell Size	6.35 μm(H) × 7.4 μm(V)	6.5 μm(H) × 6.25 μm(V)
Minimum Illumination	0.003 lx. F1.4	

WAT-525EX2/535EX2

Model	WAT-525EX2 (EIA)	WAT-525EX2 (CCIR)
Number of Total Pixels	811(H) × 508(V)	795(H) × 596(V)
Number of Effective Pixels	768(H) × 494(V)	752(H) × 582(V)
Sync. System	Internal / External (Auto-select)	
Scanning System	2:1 interlaced	
Video Output	Composite video, 1.0 V(p-p) 75 Ω (Unbalanced)	
External Sync. System	C. video / C. sync.	
External Sync. Signal Level	Sync. Signal portion 0.2-5.0 V(p-p)	
Resolution (H)	More than 570TVL (Center)	
S/N	More than 54dB (AGC=5dB, γ=1.0)	
AE Mode	OFF	1/60 sec.
	FL	1/100 sec.
	ES	1/250, 1/500, 1/1000, 1/2000, 1/5000, 1/10000, 1/100000 sec.
	EI	1/60-1/100000 sec.
AGC	HI: 5-32dB / LO: 5-20dB	
MGC	5-32dB	
Gamma Characteristics	γ ≒ 0.45(ON) / γ = 1.0(OFF)	
Lens iris	Video / DC (EIAJ arrangement, Auto-select)	
Back Light Compensation	ON / OFF	
Power Supply	DC+12V ± 10%	
Power Consumption	1.08W (90mA)	
Operating Temperature	-10 - +50°C	
Operating Humidity	Less than 95% RH (Without condensation)	
Storage Temperature	-30 - +70°C	
Storage Humidity	Less than 95% RH (Without condensation)	
Lens Mount	CS-mount (Back focus adjustable)	
Size	43.5(W) × 44(H) × 53.5(D) mm	
Weight	Approx. 120g	

- Design and specifications are subject to change without notice.
- Watec is not responsible for any inconvenience or the attendant damages to the video and monitoring recording equipment caused by misuse, mis-operation or improper wiring of our equipment.
- If for any reason the WAT-525EX2/535EX2 does not work properly, or if you have any questions regarding installation or operation, please contact the distributor or dealer from which it was purchased.

Contact information

Watec Watec Co., Ltd.

Add.: 254-2 Nihonkoku, Daihoji, Tsuruoka- Shi,
Yamagata-Ken, 997-0017 Japan
TEL: +81-235-23-4400 FAX: +81-235-23-4409
Email: info-o@watec.co.jp
URL: http://www.watec.co.jp