



This operation manual covers safety, camera functions, installation and the correct operating procedure for the WAT-600CX. First, we ask you to read this operation manual thoroughly, then install and operate the WAT-600CX as advised. In addition, for future reference, we also advise safekeeping of this manual.

Please contact the distributor or dealer from which the WAT-600CX was purchased, if you do not understand the installation, operation or safety instructions laid out in this manual. Not understanding the contents of the operation manual sufficiently may cause damage to the camera.

Guide to the Safety Symbols

The definitions of the symbols used in this operation manual are:



When you do not adhere to or take notice of the "Danger" sign, it may lead to a serious accident such as death or injury caused by fire or electric shock.

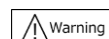

When you do not adhere to or take notice of the "Warning" sign, it may cause severe damage such as a physical injury.

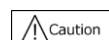

When you do not adhere to or take notice of the "Caution" sign, it may incur injury and cause damage to peripheral objects in the immediate surroundings.

Cautions for Safety

The WAT-600CX is designed to be used safely; however, it may lead to a physical accident caused by fire and electric shock if not used correctly. Therefore, please keep and read the "Cautions for safety" below for protection against accidents.



- Do not disassemble and/or modify the WAT-600CX.
- Do not operate the WAT-600CX with wet hands.

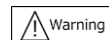

- Use only the AC adaptor with the WAT-600CX set.
- Do not use the WAT-600CX under unusual environmental conditions. The WAT-600CX is designed and approved for indoor use only. The WAT-600CX is not water-resistant, dustproof, or explosion proof. If the location of the camera is outdoors or in an outdoor like environment, we recommend that you use an outdoor camera housing.

- Protect the WAT-600CX from condensation. Keep the WAT-600CX dry at all times during storage and operation.
- Should the camera not work properly, switch off the power immediately. Then check the camera according to the "Problems and Trouble shooting" section.

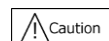

- Avoid the striking of hard objects or dropping the WAT-600CX. The WAT-600CX uses high quality electrical parts and precision components.
- The WAT-400RX must be used with the WAT-600CX. Only the WAT-400RX should be attached to the WAT-600CX BNC terminal. Connecting a monitor directly to this terminal will not provide a picture.
- Do not install the WAT-600CX in a position subject to direct sunlight. Sunlight shinning directly onto the WAT-600CX lens can cause damage to the CCD.
- Select a stable place for installation of the WAT-600CX. Use a support of durable strength around an installation position on a ceiling or wall when a camera stand or tripod is used.
- Do not move the WAT-600CX with the cables connected. Before moving the WAT-600CX, always remove the cable(s) from the rear of the camera first.
- Avoid using the WAT-600CX near any strong electromagnetic field. After installing into main equipment, if the WAT-600CX is exposed to electromagnetic waves causing the monitored image to become distorted, we recommend the camera be shielded by appropriate protective casing.

Problems and Trouble Shooting

If any of the following problems occur when using the WAT-600CX,

- An optimal picture cannot be obtained, after checking that all the cables and connections are correctly in place.
- Smoke or any unusual odor emerges from the WAT-600CX.
- An object becomes embedded or a quantity of liquid seeps into the camera housing.
- More than the recommended voltage or/and amperage has been applied to the WAT-600CX by mistake.
- Anything unusual occurring to any equipment connected to the WAT-600CX.

Disconnect the camera immediately according to the following procedures:

- Switch off the main power supply to the camera.
- Remove the cable(s) connected to the WAT-600CX.
- Contact the distributor or dealer from which the WAT-600CX was purchased.

Contents

Using the contents figures below, check to make sure all parts are present before use.

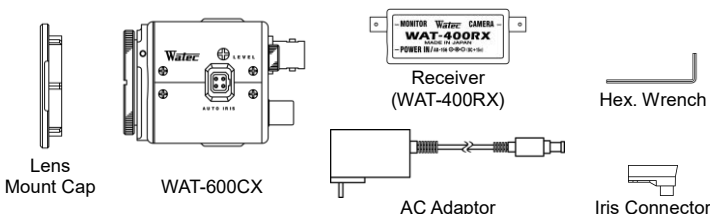

Description of Parts

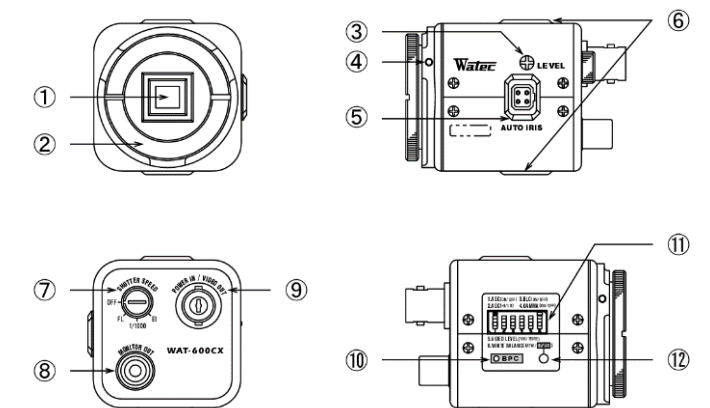

- CCD FRONT FACE**
The light receiving face of the CCD camera (Dirt, water or oil deposits on the CCD will cause an unclear picture on the monitor. Attach the lens cap to protect the lens and the CCD from contamination and damage.).
- LENS MOUNT**
Mount for the lens. (CS-mount)
- IRIS LEVEL VOLUME**
By controlling the volume, the iris level of the DC iris lens can be adjusted.
- FOCUSING ADJUSTMENT SCREWS**
There are 3 hex. adjustment screws each placed at intervals of 120° for fine focusing of the lens.
- AUTO-IRIS SOCKET**
This socket is for the video/DC auto-iris lens cable connector. (Video/DC: Auto selected by the camera)
- TRIPOD MOUNTING SCREW HOLES**
Mounting holes for stands. The size of these threads are 1/4", 20 threads, 4.5±0.2mm, which is the same as any standard camera tripod (U1/4").
- AE MODE CONTROL**
The switch for the shutter speed mode control according to the object being monitored.
- TEST VIDEO OUT (RCA)**
The video out terminal for test monitoring at the camera location.
- VIDEO OUT/POWER IN (BNC)**
The terminal for composite video signal output and power input.

- WHITE BLEMISH CORRECTION**
The button for correction of white blemish.
- FUNCTION SWITCHES**
Functional switches for setting AGC, gamma control, BLC (Back light compensation), video level, and white balance modes.
- PUSH-LOCK WHITE BALANCE BUTTON**
The button for manual setting of the white balance if the white balance mode is set to PWB.

Auto-iris Lens

Before connecting the auto-iris lens, please make sure that the pin configuration is correct by confirming with the following table. If the configuration of your iris connector is different from the following, the plug and pins will need to be rewired.

Pin No.	EIAJ Video Auto-iris Lens Arrangement	EIAJ DC Auto-iris Lens Arrangement
①	Power	Control -
②	Not used	Control +
③	Iris signals	Drive +
④	Common (GND)	Drive -

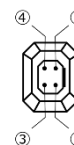

※ Maximum cable length for operation of the WAT-600CX depends on which lens is used. For example, 100m is the maximum cable length for the WAT-600CX when an auto-iris lens with a current consumption of 50mA is applied.

Wiring Diagram

The following diagram is the basic connection of the WAT-600CX, WAT-400RX, AC adaptor and monitor.

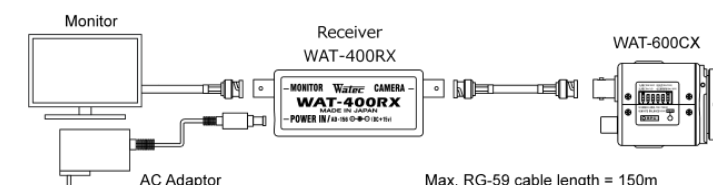

Set-up and Operation

- Ensure that the power to the WAT-600CX and the peripheral equipment is turned off before making any connections.
- Remove the lens mount cap from the WAT-600CX and attach the CS-mount lens. Use the optional C-mount adaptor (30CMA-R) when a C-mount lens is used.
- Connect the iris control cable to ⑤AUTO-IRIS SOCKET on the WAT-600CX when an auto-iris lens is being used.
- Connect ⑨ VIDEO OUT/POWER IN of the WAT-600CX to the "CAMERA" connection terminal of the WAT-400RX. Use a coaxial cable with 75Ω impedance, such as an RG-59. The maximum cable length for the WAT-600CX attached to a manual iris lens is 150m using an RG-59 cable.
- Connect the VIDEO OUT (MONITOR) on the WAT-400RX to the video signal input terminal of a monitor using a coaxial cable with 75Ω impedance, such as an RG-59.
※ Select a monitor with the same television system as the WAT-600CX: NTSC or PAL. A monitor with more than 600TV lines is recommended.
※ Do not connect the WAT-600CX or the WAT-400RX with any monitor using a video in/power out single transmission terminal. The WAT-600CX and the WAT-400RX are not designed for use with this type of equipment and receiving power through a monitor will cause damage to both the WAT-600CX and the WAT-400RX.
- Connect the attached AC adaptor to the POWER IN connector of the WAT-400RX.
- When a monitor test of the camera angle of view and functional settings at the location is required, connect ③TEST VIDEO OUT of the WAT-600CX to the monitor using a coaxial cable with 75Ω impedance, such as an RG-58/U.

- Turn on the power to the WAT-600CX, monitor and all the other allied equipment. When a picture cannot be obtained on the monitor, check and follow the procedure mentioned in the "Problems and Trouble Shooting" section.
- After following the procedure below and the picture is still out of focus, open the iris fully and loosen ④FOCUSING ADJUSTMENT SCREWS with the hex. wrench and move the lens forwards until a clear picture is obtained.

Manual Lens	Adjust the focus and iris to the best position on the lens.
Video Auto-iris Lens	Adjust the focus on the lens.
DC Auto-iris Lens	Adjust the iris level on the camera, then adjust the focus on the lens. See below.

Iris Level Adjustment (for DC auto-iris lenses only)

Adjust ③IRIS LEVEL VOLUME placed on the side of the unit until an acceptable light level is attained. No change will occur if a video iris lens or manual iris lens is fitted.

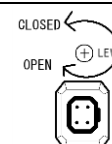

- Select any required shutter speed mode by the ⑦AE MODE CONTROL. (Factory default: EI)

AE Mode	Effect
OFF	Fixes the shutter speed to NTSC1/60, PAL 1/50.
FL	Reduces the flickering phenomena occurring on the monitor screen caused by fluorescent or mercury lamps.
1/1000	Fixes the shutter speed to 1/1000
EI (Flicker suppress)	For electronic iris reducing the flickering phenomena occurring on the monitor screen caused by fluorescent or mercury lamps.

※ In EI mode, intense light may leave a trail on the screen longitude. This smearing is a natural phenomenon and is not due to equipment failure or fault.

- Set the ⑪FUNCTION SWITCHES according to requirements.

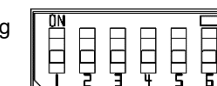

Switch	Setting	Effective Condition	Factory default
1. AGC	ON	When sensitivity is more important than the SN ratio	✓
	OFF	When SN ratio is more important than sensitivity, or when a stable lighting condition is present	
2. AGC	ON [HI]	When sensitivity is more important than SN ratio	✓
	OFF [LO]	When SN ratio is more important than sensitivity, in addition AGC is also required	
3. BLC*	ON	When the picture of the monitored object is silhouetted due to strong lighting from above or behind	
	OFF	When the illumination differences between a monitored object is narrow	✓
4. Gamma Correction	ON	Applicable to a general surveillance monitoring system	✓
	OFF	When gamma correction is not required for image processing	
5. Video Level	ON [100]	When dark areas on an object with contrasting light and dark area are monitored	
	OFF [75]	When the standard video output level is required	✓
6. White Balance	ON [ATW]	Automatically follows and adjusts to the changing color temperature of the illumination	✓
	OFF [PWB]	Adjusted with ⑫ PUSH-LOCK WHITE BALANCE BUTTON according to the color temperature of the environment and fixes the resultant color temperature at that setting	

※ When BLC is used and ⑦AE MODE CONTROL setting is set to either OFF, FL, or 1/1000, please apply an auto iris lens.

- 12) Correct white blemish(s) by **⑩ WHITE BLEMISH CORRECTION BUTTON**. The WAT-600CX is manufactured using high-grade CCD devices that are selected by tough standards by the manufacturer. However, it is impossible to prevent the white blemishes from occurring after shipment because the white blemish phenomena can be caused by cosmic rays. The WAT-600CX has a white blemish correction circuit to help control the white blemish phenomena. Correct according to the following procedures, if white blemishes are present.

[PROCEDURE]

1. Completely cover the lens to prevent light entering.
 2. Set to AGC ON by **⑪ FUNCTION SWITCHES**.
 3. Set the white balance mode to PWB by **⑪ FUNCTION SWITCHES**.
 4. Press the **⑩ WHITE BLEMISH CORRECTION BUTTON** using a fine stick.
 5. After 5 seconds, the white blemishes are automatically detected, and then recorded to the camera.
- ※ Make sure that the lens is completely shielded from light before correction of the white blemishes. If the lens is not covered properly and light can enter into the lens on to the CCD face, the correction of the white blemish may not be detected correctly.
- ※ Make sure that "PWB" setting is selected by **⑪ FUNCTION SWITCHES**. If ATW position is selected; the data cannot be saved to the camera.

Options

To purchase these options, please contact the distributor or dealer from which you purchased the WAT-600CX.



C-mount Adaptor (34CMA-R)

This lens mount adaptor is used to convert a CS-mount to a C-mount.



Mini Stand (MS50)

A convenient stand for the WAT-600CX. With this stand, the camera can be adjusted to any desired angle.

Specifications

Model	WAT-600CX (NTSC)	WAT-600CX (PAL)	
Pick-up Element	1/3 inch interline transfer CCD image sensor		
Number of Total Pixels	811(H) × 508(V)	795(H) × 596(V)	
Number of Effective Pixels	768(H) × 494(V)	752(H) × 582(V)	
Unit Cell Size	6.35um(H) × 7.4um(V)	6.5um(H) × 6.25um(V)	
Imaging System	Ye, Cy, Mg, and G complementary color mosaic filters on chip		
Sync. System	Internal		
Scanning System	2:1 interlace		
Video Outputs	· BNC: VIDEO OUT/POWER IN · RCA: Composite video, 1.0 V(p-p) 75 Ω (Unbalanced)		
Resolution (H)	More than 540TVL (Center)		
Minimum Illumination	0.02 lx. F1.2		
S/N	More than 50dB (AGC=0dB, γ = 1.0)		
AE Mode	OFF	1/60 sec.	1/50 sec.
	FL	1/100 sec.	1/120 sec.
	ES	1/1000 sec.	
	EI (Flicker suppress)	1/60-1/100000 sec.	1/50-1/100000 sec.
White Balance	ATW (Color rolling less), PWB		
AGC	ON	HI: 0-38dB / LO: 0-32dB	
	OFF	0dB	
Gamma Characteristics	γ ≒ 0.45(ON) / γ = 1.0(OFF)		
Video level	100IRE / 75IRE		
Lens iris	Video / DC (EIAJ arrangement, Auto-select)		
Back Light Compensation	ON / OFF		
White blemish correction	Up to 32 dots		
Power Supply	DC+15V		
Power Consumption	3.3W (220mA)		
Operating Temperature	-10 - +50°C		
Operating Humidity	Less than 95% RH (Without condensation)		
Storage Temperature	-30 - +70°C		
Storage Humidity	Less than 95% RH (Without condensation)		
Lens Mount	CS-mount (Back focus adjustable)		
Size	44(W) × 44(H) × 64(D) mm		
Max. cable length*	150m (RG-59)		
Weight	Approx. 140g		

※ The normal operation of the WAT-600CX with a maximum cable length (150m) is only ensured when a manual iris lens is used.

- Design and specifications are subject to change without notice.
- Watec is not responsible for any inconvenience or the attendant damages to the video and monitoring recording equipment caused by misuse, mis-operation or improper wiring of our equipment.
- If for any reason the WAT-600CX does not work properly, or if you have any questions regarding installation or operation, please contact the distributor or dealer from which it was purchased.

Contact information



Add.: 254-2 Nihonkoku, Daihoji, Tsuruoka- Shi,
Yamagata-Ken, 997-0017 Japan
TEL: +81-235-23-4400 FAX: +81-235-23-4409
Email: info-o@watec.co.jp
URL: http://www.watec.co.jp