



Monochrome CCD Camera

WAT-902H2 ULTIMATE WAT-902H3 ULTIMATE

Operation Manual

This Operation Manual covers safety, camera functions, installation and the correct operating procedure for the WAT-902H2/3 ULTIMATE. First, we ask you to read this Operation Manual thoroughly, then install and operate the WAT-902H2/3 ULTIMATE as advised. In addition, for future reference, we also advise safekeeping of this manual.

Please contact the distributor or dealer from which the WAT-902H2/3 ULTIMATE was purchased, if you do not understand the installation, operation or safety instructions laid out in this manual. Not understanding the contents of the Operation Manual sufficiently may cause damage to the camera.

Guide to the Safety Symbols

The definitions of the symbols used in this operation manual are:

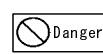

When you do not adhere to or take notice of the "Danger" sign, it may lead to a serious accident such as death or injury caused by fire or electric shock.

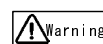

When you do not adhere to or take notice of the "Warning" sign, it may cause severe damage such as a physical injury.

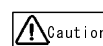

When you do not adhere to or take notice of the "Caution" sign, it may incur injury and cause damage to peripheral objects in the immediate surroundings.

Cautions for Safety

WAT-902H2/3 ULTIMATE is designed to be used safely; however, if not used safely, it may lead to a physical accident caused by fire and electric shock. Therefore, please keep and read the "Cautions for Safety" below for protection against accidents.

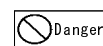

- Do not disassemble and/or modify the WAT-902H2/3 ULTIMATE.
- Do not operate the WAT-902H2/3 ULTIMATE with wet hands.

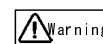

- Use a stabilized power adaptor designed for DC+12V±10%, with a current capacity of more than 250mA for the WAT-902H2/3 ULTIMATE.

The recommended voltage is DC+12V±10%

- Do not expose the WAT-902H2/3 ULTIMATE to wetness or high moisture conditions.

The WAT-902H2/3 ULTIMATE is designed and approved for indoor use only. The WAT-902H2/3 ULTIMATE is not water-resistant or waterproof. If the location of the camera is outdoors or in an outdoor like environment, we recommend that you use an outdoor camera housing.

- Protect the WAT-902H2/3 ULTIMATE from condensation.

Keep the WAT-902H2/3 ULTIMATE dry at all times during storage and operation.

- Should the camera not work properly, switch off the power immediately. Then check the camera according to the "Problems and Trouble Shooting" section.

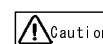

- Avoid the striking of hard objects or dropping the WAT-902H2/3 ULTIMATE.

The WAT-902H2/3 ULTIMATE uses high quality electrical parts and precision components.

- Do not connect any power supply directly to the video out terminal of the unit.

Do not connect the WAT-902H2/3 ULTIMATE with any monitor using a video/power single transmission terminal. The WAT-902H2/3 ULTIMATE is not designed for use with this type of equipment. We also advise you to read the operation manual of the monitor you plan to use before any connections are made.

- Do not install the WAT-902H2/3 ULTIMATE in a position subject to direct sunlight.

Sunlight shinning directly onto the WAT-902H2/3 ULTIMATE lens can cause damage to the CCD.

- Select a stable place for installation of the WAT-902H2/3 ULTIMATE.

Use a support of durable strength around an installation position on a ceiling or wall when a camera stand or tripod is used.

- Do not move the WAT-902H2/3 ULTIMATE with the cables connected.

Before moving the WAT-902H2/3 ULTIMATE, always remove the video cable and power cable from the rear of the camera first.

- Avoid using the WAT-902H2/3 ULTIMATE near any strong electromagnetic field.

After installing into main equipment, if the WAT-902H2/3 ULTIMATE is exposed to electromagnetic waves causing the monitored image to become distorted, we recommend the camera be shielded by appropriate protective casing.

Problems and Trouble Shooting

If any of the following problems occur when using the WAT-902H2/3 ULTIMATE,

- An optimal picture cannot be obtained, after checking that all the cables and connections are correctly in place
- Smoke or any unusual odor emerges from the WAT-902H2/3 ULTIMATE.
- An object becomes embedded or a quantity of liquid seeps into the camera housing
- More than the recommended voltage or/and amperage has been applied to the WAT-902H2/3 ULTIMATE by mistake
- Anything unusual occurring to any equipment connected to the WAT-902H2/3 ULTIMATE.

Disconnect the camera immediately according to the following procedures:

- Switch off the main power supply to the camera.
- Remove the power and video cables connected to the WAT-902H2/3 ULTIMATE.
- Contact the distributor or dealer from which the WAT-902H2/3 ULTIMATE was purchased.

About EMC

The WAT-902H2/3 ULTIMATE is in conformity with EMC test standards carried out by authorized organizations in Japan.

E I A FCC Part15 class B

CCIR EN61000-6-3/EN50130-4

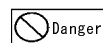

Do not modify the WAT-902H2/3 ULTIMATE. A modified camera may not conform to EMC test standards.

Contents

Using the contents figures below, check to make sure all parts are present before use.

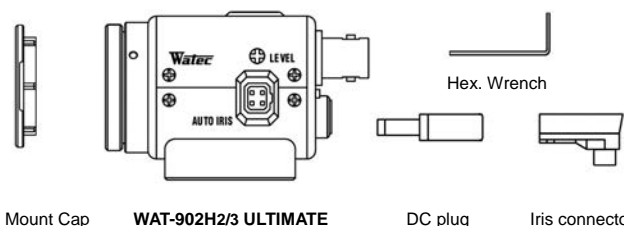

Lens Mount Cap WAT-902H2/3 ULTIMATE DC plug Iris connector

Description of Parts

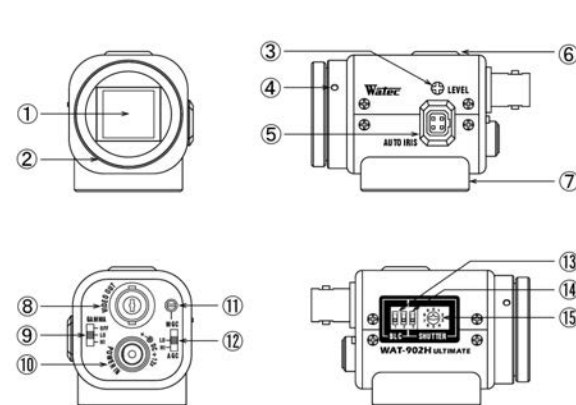

① CCD FRONT FACE

- The light receiving face of the CCD camera (Dirt, water or oil deposits on the CCD will cause an unclear picture on the monitor. Attach the lens cap to protect the lens and CCD from contamination and damage.)

② LENS MOUNT

- Mount for the lens (Thread type)

③ IRIS LEVEL VOLUME

- By controlling the volume, the iris level of a DC iris lens can be adjusted.

④ FOCUSING ADJUSTMENT SCREWS

- There are 3 hex. adjustment screws each placed at intervals of 120° for fine focusing of the lens.

⑤ AUTO-IRIS SOCKET

- This socket is for a video or DC auto-iris lens cable connector. (Video/DC: Auto selected by the camera)

⑥ TRIPOD MOUNTING SCREW HOLES

- Mounting holes for stands. The size of these threads are 1/4", 20 threads, 4.5 ± 0.2mm, which is the same as any standard camera tripod (U1/4").

⑦ CAMERA BASE

- The camera base has a thread for fixing to a standard tripod and four M3 size holes for additional easy fixing.

⑧ VIDEO OUT (BNC)

- The terminal for composite video signal output

⑨ GAMMA CORRECTION SWITCH

- Three gamma values are selectable, 1.0, 0.45, 0.35.

⑩ POWER IN

- The terminal designed for the DC-plug of the power adaptor

⑪ MGC VOLUME ADJUSTING

- The volume for setting manual gain control

⑫ AGC/MGC SELECTION SWITCH

- Switch for setting AGC HI, LO or MGC

⑬ BACK LIGHT

- The switch for back light compensation

⑭ ELECTRONIC SHUTTER ON/OFF SWITCH

- The switch for the selecting electronic shutter mode

⑮ AE MODE CONTROL

- The switch for the shutter speed mode control according to the object being monitored

Power Supply

Use a stabilized power adaptor designed for DC+12V±10%, with a current capacity of more than 250mA.

Use the optional DC plug if the shape or polarity of the DC plug of the power adaptor to be used is not compatible with the camera (See the drawing on the right below).

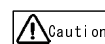
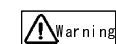

The wiring on the connector must be exact. Be careful not to touch the other terminal while wiring. Protect the wiring portion by using insulation tape after wiring. If the above care and attention is not adhered to, damage to the WAT-902H2/3 ULTIMATE and power adaptor may occur and may also cause fire.

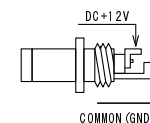

Auto-iris Lens

Before connecting the auto-iris lens, please make sure that the pin configuration is correct by confirming with the following table. If the configuration of your iris connector is different from the following, the plug and pins will need to be rewired.

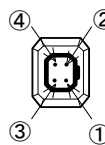

Pin No.	EIAJ Video Auto-iris Lens Arrangement	EIAJ DC Auto-iris Lens Arrangement
①	Power	Control -
②	Not used	Control +
③	Iris signals	Drive +
④	Common (GND)	Drive -

Camera Base

There is a tripod mounting screw hole as shown in the diagram on the right. In addition, there are 4 corners holes M3 size and one φ5 for stability.

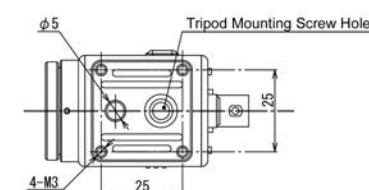

Set-up and Operation

- Ensure that the power to the WAT-902H2/3 ULTIMATE and the peripheral equipment is turned off before making any connections.
- Remove the lens mount cap from the WAT-902H2/3 ULTIMATE and attach the CS-mount lens. Use the optional C-mount adaptor (30CMA-R) when a C-mount lens is used.
- Connect the iris control cable to ⑤ AUTO-IRIS SOCKET on the WAT-902H2/3 ULTIMATE when an auto-iris lens is being used.
- Connect ⑧ VIDEO OUT on the WAT-902H2/3 ULTIMATE with the monitor, using a coaxial cable with 75Ω impedance, such as an RG-59 or an RG-6/U. Select a monitor with the same television system as the WAT-902H2/3 ULTIMATE: EIA or CCIR. A monitor with more than 600TV lines is recommended.
- Insert the power plug of the power adaptor into ⑩ POWER IN on the back panel of the WAT-902H2/3 ULTIMATE. Confirm that the power adaptor is not connected to the power supply before insertion of the power plug into ⑩ POWER IN.
- Turn on the power to the WAT-902H2/3 ULTIMATE, monitor and all other allied equipment. When a picture cannot be obtained on the monitor, or a problem occurs, check and follow the procedure mentioned in the [Problems and Trouble Shooting] section.
- After following the procedure below and the picture is still out of focus, open the iris fully and loosen ④ FOCUSING ADJUSTMENT SCREWS with the hex. wrench and move the lens forwards until a clear picture is obtained.

Manual Lens	Adjust the focus and iris to the best position on the lens.
Video Auto-iris Lens	Adjust the focus on the lens.
DC Auto-iris Lens	Adjust the iris level on the camera, then adjust the focus on the lens. See below.

Iris Level Adjustment (for DC auto-iris lenses only)

Adjust ③ IRIS LEVEL VOLUME placed on the side of the unit until an acceptable light level is attained. No change will occur if a video iris lens or manual iris lens is fitted.

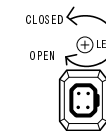

- Select any required gamma by the ⑨ GAMMA CORRECTION SWITCH.

Mode	Gamma	Effect
OFF	1.0	Required for image processing such as data storage for PCs and for FA.
LO	0.45	Standard setting for using TVs and Monitors. Natural images can be obtained in dark areas.
HI	0.35	Dark areas can be lightened and bright areas can be reduced.

※Select LO position for normal use. In a low light environment or dark viewing, HI mode is recommended.

※The switch is set to LO (γ ≈ 0.45) upon shipment.

- Select any required gain control by the ⑫ AGC/MGC SELECTION SWITCH.

Mode	Range	Effect
MGC	5 - 60dB	<ul style="list-style-type: none"> In a low light environment, when illumination of the object is important, increase the manual gain. Lower the gain control for a clearer picture with less noise. (Factory automation or Image processing)
AGC HI	5 - 60dB	<ul style="list-style-type: none"> When minimum illumination is more important than the S/N ratio (Surveillance in a low light environment)
AGC LO	5 - 32dB	<ul style="list-style-type: none"> When SN ratio is more important than minimum illumination. When adequate lighting is present or a stable lighting condition is available.

※The switch is set to LO(5-32dB) upon shipment.

- Set the gain to any required environment by ⑪ MGC VOLUME ADJUSTING. Manually adjusted in a range between 5 to 60dB. In a low light environment, when illumination of the object is important, increase the manual gain. Lower the gain control for a clearer picture with less noise. ※The volume is set to L(Min.) upon shipment.

- 11) Select any required back light area by ⑬BACK LIGHT to one of its 4 positions.

	Area	Switch
1. Default		
2. Center		
3. Lower		
4. Center - Lower		

※The switches are set to OFF(Default) upon shipment.

- 12) Set the shutter mode by ⑭ELECTRONIC SHUTTER ON/OFF SWITCH
When shutter mode is OFF, fix the shutter speed to EIA1/60, CCIR1/50.
When shutter mode is ON, select the shutter speed mode by ⑮AE MODE CONTROL.

※The switch is set to OFF upon shipment.

- 13) Select any required shutter speed by the ⑮AE MODE CONTROL to one of its 10 positions.

No.	Mode	Shutter Speeds (Sec.)	
		EIA	CCIR
0	FL	1/100	1/120
1	ES	1/250	
2	ES	1/500	
3	ES	1/1000	
4	ES	1/2000	
5	ES	1/5000	
6	ES	1/10000	
7	ES	1/100000	
8	EI: OFF	1/60-1/100000	1/50-1/100000
9	EI: FL	1/100-1/100000	1/120-1/100000

※An intense light may leave a trail on the screen longitude. This smearing is a natural phenomenon and is not due to equipment failure or fault.

※The dial is set to 0(FL) upon shipment.

Options

To purchase these options, please contact the distributor or dealer from which you purchased the WAT-902H2/3 ULTIMATE.



C-mount Adaptor (30CMA-R)

This lens mount adaptor is used to convert a CS-mount to a C-mount.



Mini Stand (MS50)

A convenient stand for the WAT-902H2/3 ULTIMATE. With this stand, the camera can be adjusted to any desired angle.

Specifications

WAT-902H2 ULTIMATE

Model	WAT-902H2 ULTIMATE	
	EIA	CCIR
Pick-up Element	1/2 inch interline transfer CCD image sensor	
Unit Cell Size	8.4 μm(H) × 9.8 μm(V)	8.6 μm(H) × 8.3 μm(V)
Minimum Illumination	0.0001 lx. F1.4	
Power Consumption	1.38W (115mA)	

WAT-902H3 ULTIMATE

Model	WAT-902H3 ULTIMATE	
	EIA	CCIR
Pick-up Element	1/3 inch interline transfer CCD image sensor	
Unit Cell Size	6.35 μm(H) × 7.4 μm(V)	6.5 μm(H) × 6.25 μm(V)
Minimum Illumination	0.0002 lx. F1.4	
Power Consumption	1.32W (110mA)	

WAT-902H2 ULTIMATE / WAT-902H3 ULTIMATE

Model	WAT-902H2/3 ULTIMATE	
	EIA	CCIR
Number of Total Pixels	811(H) × 508(V)	795(H) × 596(V)
Number of Effective Pixels	768(H) × 494(V)	752(H) × 582(V)
Sync. System	Internal	
Scanning System	2:1 interlace	
Video Output	Composite video, 1.0 V(p-p) 75Ω (Unbalanced)	
Resolution (H)	More than 570TVL (Center)	
S/N	More than 50dB (AGC=5dB, γ=1.0)	
AE Mode	OFF	1/60 sec. / 1/50 sec.
	FL	1/100 sec. / 1/120 sec.
	ES	1/250, 1/500, 1/1000, 1/2000 1/5000, 1/10000, 1/100000 sec.
	EI: OFF	1/60-1/100000 sec. / 1/50-1/100000 sec.
	EI: FL	1/100-1/100000 sec. / 1/120-1/100000 sec.
AGC	HI: 5-60dB / LO: 5-32dB	
MGC	5-60dB	
Gamma Characteristics	γ ≈ 0.35(HI) / γ ≈ 0.45(LO) / γ = 1.0(OFF)	
Lens iris	Video / DC (EIAJ arrangement, Auto-select)	
Back Light Compensation	ON / OFF	
Power Supply	DC+12V ± 10%	
Operating Temperature	-10 - +40°C	
Operating Humidity	Less than 95% RH (Without condensation)	
Storage Temperature	-30 - +70°C	
Storage Humidity	Less than 95% RH (Without condensation)	
Lens Mount	CS-mount (Back focus adjustable)	
Size	36(W) × 40(H) × 63(L) (mm)	
Weight	Approx. 98g	

- Design and specifications are subject to change without notice.
- Watec is not responsible for any inconvenience or the attendant damages to the video and monitoring recording equipment caused by misuse, mis-operation or improper wiring of our equipment.
- If for any reason the WAT-902H2/3 ULTIMATE does not work properly, or if you have any questions regarding installation or operation, please contact the distributor or dealer from which it was purchased.

Contact information

Watec Watec Co., Ltd.

Add.: 254-2 Nihonkoku, Daihoji, Tsuruoka- Shi,
Yamagata-Ken, 997-0017 Japan
TEL: +81-235-23-4400 FAX: +81-235-23-4409
Email: info-o@watec.co.jp
URL: http://www.watec.co.jp