

# WAT-910HX/RC

## Operation Manual

This Operation Manual covers safety, camera functions, installation and the correct operating procedure for the WAT-910HX/RC. First, we ask you to read this Operation Manual thoroughly, then install and operate the WAT-910HX/RC as advised. In addition, for future reference, we also advise safekeeping of this manual.

Please contact the distributor or dealer from which the WAT-910HX/RC was purchased, if you do not understand the installation, operation or safety instructions laid out in this manual. Not understanding the contents of the Operation Manual sufficiently may cause damage to the camera.

### Guide to the Safety Symbols

The definitions of the symbols used in this operation manual are:

- When you do not adhere to or take notice of the "Danger" sign, it may lead to a serious accident such as death or injury caused by fire or electric shock.
- When you do not adhere to or take notice of the "Warning" sign, it may cause severe damage such as a physical injury.
- When you do not adhere to or take notice of the "Caution" sign, it may incur injury and cause damage to peripheral objects in the immediate surroundings.

### Cautions for Safety

The WAT-910HX/RC is designed to be used safely; however, if not used safely, it may lead to a physical accident caused by fire and electric shock. Therefore, please keep and read the "Cautions for safety" below for protection against accidents.

- Do not disassemble and/or modify the WAT-910HX/RC.**  
**Do not operate the WAT-910HX/RC with wet hands.**
- Use a stabilized power adaptor designed for DC+12V±10%, with a current capacity of more than 250mA for the WAT-910HX/RC.**  
The recommended voltage is DC+12V±10%
- Do not expose the WAT-910HX/RC to wetness or high moisture conditions.**  
The WAT-910HX/RC is designed and approved for indoor use only. The WAT-910HX/RC is not water-resistant or waterproof. If the location of the camera is outdoors or in an outdoor like environment, we recommend that you use an outdoor camera housing.
- Protect the WAT-910HX/RC from condensation.**  
Keep the WAT-910HX/RC dry at all times during storage and operation.
- Should the camera not work properly, switch off the power immediately. Then check the camera according to the "Problems and Trouble shooting" section.

- Avoid the striking of hard objects or dropping the WAT-910HX/RC.**  
The WAT-910HX/RC uses high quality electrical parts and precision components.
- Do not connect any power supply directly to the video out terminal of the unit.**  
Do not connect the WAT-910HX/RC with any monitor using a video/power single transmission terminal. The WAT-910HX/RC is not designed for use with this type of equipment. We also advise you to read the operation manual of the monitor you plan to use before any connections are made.

- Do not install the WAT-910HX/RC in a position subject to direct sunlight.**  
Sunlight shining directly onto the WAT-910HX/RC lens can cause damage to the CCD.
- Select a stable place for installation of the WAT-910HX/RC.**  
Use a support of durable strength around an installation position on a ceiling or wall when a camera stand or tripod is used.
- Do not move the WAT-910HX/RC with the cables connected.**  
Before moving the WAT-910HX/RC, always remove the video cable and power cable from the rear of the camera first.
- Avoid using the WAT-910HX/RC near any strong electromagnetic field.**  
After installing into main equipment, if the WAT-910HX/RC is exposed to electromagnetic waves causing the monitored image to become distorted, we recommend the camera be shielded by appropriate protective casing.

### Problems and Trouble Shooting

If any of the following problems occur when using the WAT-910HX/RC,

- An optimal picture cannot be obtained, after checking that all the cables and connections are correctly in place
- Smoke or any unusual odor emerges from the WAT-910HX/RC
- An object becomes embedded or a quantity of liquid seeps into the camera housing
- More than the recommended voltage or/and amperage has been applied to the WAT-910HX/RC by mistake
- Anything unusual occurring to any equipment connected to the WAT-910HX/RC

**Disconnect the camera immediately according to the following procedures:**

- ① Switch off the main power supply to the camera.
- ② Remove the power and video cables connected to the WAT-910HX/RC.
- ③ Contact the distributor or dealer from which the WAT-910HX/RC was purchased.

### About EMC

The WAT-910HX/RC is in conformity with EMC test standards carried out by authorized organizations in Japan.

E I A FCC Part15 class B  
CCIR EN61000-6-3/EN50130-4

※Please use an auxiliary power supply (eg: UPS) to this camera to comply with EN50130-4 of EMC standards.

- Do not modify the WAT-910HX/RC. A modified camera may not conform to EMC test standards.

### Contents

Using the contents figures below, check to make sure all parts are present before use.

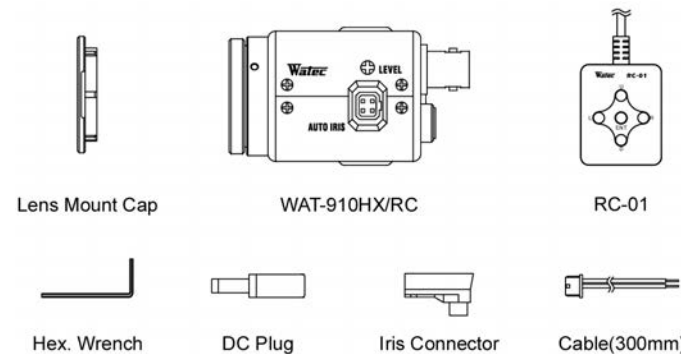

### Description of Parts

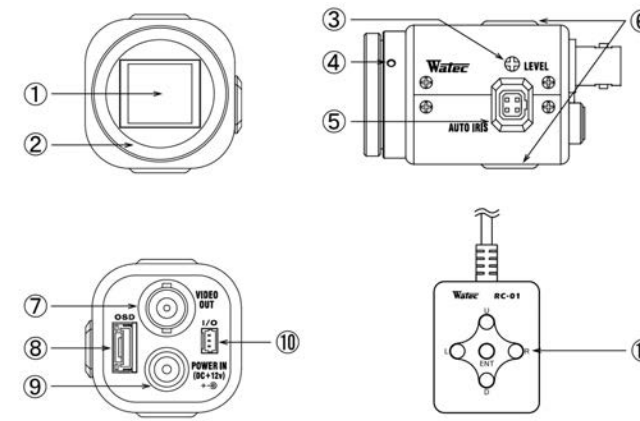

- ① IMAGE SENSOR FRONT FACE
  - The light receiving face of the image sensor
  - (Dirt, water or oil deposits on the image sensor will cause an unclear picture on the monitor. Attach the lens cap to protect the lens and the CCD from contamination and damage.)
- ② LENS MOUNT
  - Mount for the lens (CS-mount)
- ③ IRIS LEVEL VOLUME
  - By controlling the volume, the iris level of the DC iris lens can be adjusted.
- ④ FINE FOCUS ADJUSTMENT SCREWS
  - There are 3 hex. adjustment screws each placed at intervals of 120° for fine focusing of the lens.
- ⑤ AUTO-IRIS SOCKET
  - This socket is for the video/DC auto-iris lens cable connector. (Video/DC: Auto selected by the camera)
- ⑥ TRIPOD MOUNTING SCREW HOLES
  - Mounting holes for stands. The size of these threads are 1/4", 20 threads, 4.5±0.2mm, which is the same as any standard camera tripod (U1/4").
- ⑦ VIDEO OUT (BNC)
  - The terminal for composite video signal output
- ⑧ OSD(On Screen Display) CONNECTOR
  - The terminal designed for connection with the remote control for setting the functions on the screen.
- ⑨ POWER IN
  - The terminal designed for connection with the DC-plug of the power adaptor.
- ⑩ I/O CONNECTOR
  - The control terminal for the Motion Detection.
- ⑪ OPERATION BUTTON
  - The operation button for setting the functions on the screen.

### Power Supply

Use a stabilized power adaptor designed for DC+12V±10%, with a current capacity of more than 250mA. Use the optional DC plug if the shape or polarity of the DC plug of the power adaptor to be used is not compatible with the camera (See the drawing on the right below).

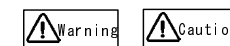

The wiring of the connector must be exact. Be careful not to touch the other terminal while wiring. Protect the wiring portion by using insulation tape after wiring. If the above care and attention is not adhered to, damage to the WAT-910HX/RC and power adaptor may occur and may also cause fire.

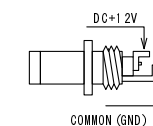

### Auto-iris Lens

Before connecting the auto-iris lens, please make sure that the pin configuration is correct by confirming with the following table. If the configuration of your iris connector is different from the following, the plug and pins will need to be rewired.

Pin No.	EIAJ Video Auto-iris Lens Arrangement	EIAJ DC Auto-iris Lens Arrangement
①	Power	Control -
②	Not used	Control +
③	Iris signals	Drive +
④	Common (GND)	Drive -

### Set-up and Operation

- 1) Ensure that the power to the WAT-910HX/RC and the peripheral equipment is turned off before making any connections.
- 2) Remove the lens mount cap from the WAT-910HX/RC and attach the CS-mount lens. Use the optional C-mount adaptor (30CMA-R) when a C-mount lens is used.
- 3) Connect the iris control cable to ⑤AUTO-IRIS SOCKET on the WAT-910HX/RC when an auto-iris lens is being used.
- 4) Connect ⑦VIDEO OUT on the WAT-910HX/RC with the monitor, using a coaxial cable with 75Ω impedance, such as an RG-59 or an RG-6/U.  
※Select a monitor with the same television system as the WAT-910HX/RC EIA or CCIR. A monitor with more than 600TV lines is recommended.
- 5) Insert the power plug of the power adaptor into ⑨POWER IN on the back panel of the WAT-910HX/RC. Confirm that the power adaptor is not connected to the power supply before insertion of the power plug into ⑨POWER IN.
- 6) Turn on the power to the WAT-910HX/RC, monitor and all other allied equipment. When a picture cannot be obtained on the monitor, or a problem occurs, check and follow the procedure mentioned in the 【Problems and Trouble Shooting】 section.
- 7) After following the procedure below and the picture is still out of focus, open the iris fully and loosen ④FINE FOCUSING ADJUSTMENT SCREWS with the hex. wrench and move the lens forwards until a clear picture is obtained.

Manual Lens	Adjust the focus and iris to the best position on the lens.
Video Auto-iris Lens	Adjust the focus on the lens.
DC Auto-iris Lens	Adjust the iris level on the camera, then adjust the focus on the lens. See below.

#### Iris Level Adjustment (for DC auto-iris lenses only)

Adjust ③IRIS LEVEL VOLUME placed on the side of the unit until an acceptable light level is attained. No change will occur if a video iris lens or manual iris lens is fitted.

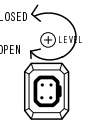

- ※When an auto iris lens is used, connect the remote control to ⑧OSD(On Screen Display) CONNECTOR, then set SHUTTER to 1/60 (1/50), SENS UP to OFF and AGC to OFF by ⑪OPERATION BUTTON. Then adjust ③IRIS LEVEL VOLUME until an acceptable light level is attained.
- 8) When detailed settings are required or an adequate image is not obtained, connect the remote control to ⑧OSD(On Screen Display) CONNECTOR, then set the functions on the screen by ⑪OPERATION BUTTON.

9) When controlling the motion detection function, connect to I/O CONNECTOR after wiring using the attached cable. See the pin configuration as follows.

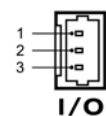

PIN No.	Cable color	Title	Function
1	Brown	MD_O	Alarm out
2	Black	GND	Camera GND
3	-	NC	

#### ■ Alarm output terminal

When the motion detection function is used, the alarm output terminals 1 and 2 are hot during detection of movement in the monitored area. If an LED is connected as shown in the diagram below, the alert turns on the LED by voltage output of 3.3V at maximum current of 6mA.

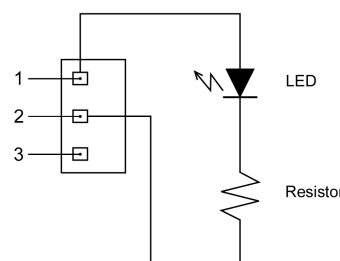

## Options

To purchase these options, please contact the distributor or dealer from which you purchased the WAT-910HX/RC.



#### **C-mount Adaptor (30CMA-R)**

This lens mount adaptor is used to convert a CS-mount to a C-mount.



#### **Mini Stand (MS50)**

A convenient stand for the WAT-910HX/RC. With this stand, the camera can be adjusted to any desired angle.

## Specifications

Model	WAT-910HX/RC (EIA)	WAT-910HX/RC (CCIR)
Pick-up Element	1/2 inch interline transfer CCD image sensor	
Number of Total Pixels	811(H) × 508(V)	795(H) × 596(V)
Number of Effective Pixels	768(H) × 494(V)	752(H) × 582(V)
Unit Cell Size	8.4μm(H) × 9.8μm(V)	8.6μm(H) × 8.3μm(V)
Sync. System	Internal	
Scanning System	2:1 Interlace	
Video Output	Composite Video, 1.0 V(p-p), 75Ω (Unbalanced)	
Resolution (H)	More than 570TVL (Center)	
Minimum Illumination	0.000025lx, F1.4 (Shutter: x256, AGC: HIGH, γ: 0.35, 3DNR ON)	
S/N	More than 52dB (AGC=6dB, γ=1.0)	
Function settings	OSD (On Screen Display) operated by remote control	
Electronic iris	1/60-1/100000 sec.	1/50-1/100000 sec.
	x256(field) *selectable -1/100000 sec.	
Electronic shutter	x2, x4, x8, x16, x32, x64, x128, x256 (field)	
	1/60, 1/100 sec.	1/50, 1/120 sec.
AGC	ON	LO: 6~30dB / MID: 6~34.5dB / HI: 6~41dB
	OFF	6-41dB (1dB step) *selectable
Gamma Characteristics	γ ≒ 0.05-1.00 (0.05 step), USER *selectable	
Noise Reduction	3DNR ON *selectable / OFF	
Wide Dynamic Range	USER1 / USER2 / OFF	
Motion Detection	Max. 4 areas selectable (Out-put terminal available)	
Lens-iris	Video / DC (EIAJ arrangement, Auto-select)	
Back Light Compensation	OFF / BLC / HSBLC	
White blemish correction	Up to 64 dots correctable by OSD operation	
Power Supply	DC+12V ± 10%	
Power Consumption	1.38W (115mA)	
Operating Temperature	-10 - +50°C	
Operating Humidity	Less than 95% RH (Without condensation)	
Storage Temperature	-30 - +70°C	
Storage Humidity	Less than 95% RH (Without condensation)	
Lens Mount	CS-mount (Back focus adjustable)	
Size	35.5(W) × 36(H) × 63.5(D) (mm)	
Weight	Approx. 83g	

- Design and specifications are subject to change without notice.
- Watec is not responsible for any inconvenience or the attendant damages to the video and monitoring recording equipment caused by misuse, mis-operation or improper wiring of our equipment.
- If for any reason the WAT-910HX/RC does not work properly, or if you have any questions regarding installation or operation, please contact the distributor or dealer from which it was purchased.

※Minimum illumination specification applies to cameras with serial numbers from W154BE01001/W154BC01001 and higher.

### Contact information



Add.: 254-2 Nihonkoku, Daihoji, Tsuruoka- Shi,  
Yamagata-Ken, 997-0017 Japan  
TEL: +81-235-23-4400 FAX: +81-235-23-4409  
Email: info-o@watec.co.jp  
URL: http://www.watec.co.jp