

# WAT-902B 1/2" Low Noise · High Sensitivity Camera

High cost performance model among the WAT-902 series



## Key features

- High sensitivity with low noise operation
- Min. illumination 0.003 lx F1.4 (AGC HIGH=32dB, Shutter=OFF)

## Dimensions

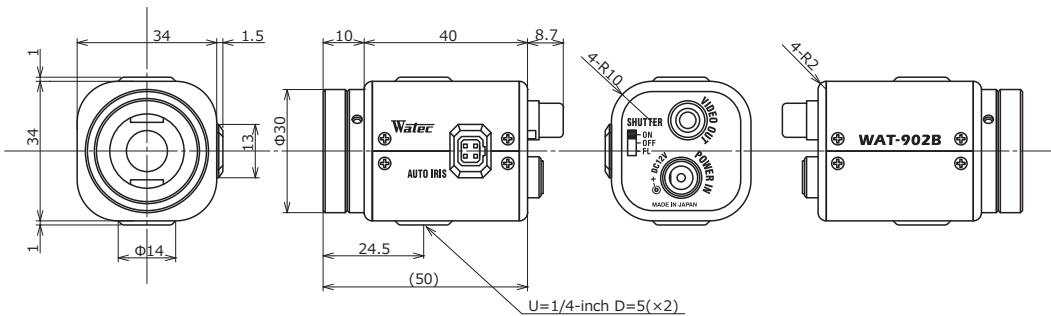

## Specifications

| Video standard               |       | EIA  | CCIR                 |
|------------------------------|-------|--|----------------------|
| Pick-up element              |       | 1/2 inch interline transfer CCD image sensor |                      |
| Number of effective pixels   |       | 768(H) × 494(V)                              | 752(H) × 582(V)      |
| Unit cell size               |       | 6.35μm(H) × 7.4μm(V)                         | 8.6μm(H) × 8.3μm(V)  |
| Synchronizing system         |       | Internal                                     |                      |
| Scanning system              |       | 2:1 interlace                                |                      |
| Video output                 |       | Composite video, 1.0 V(p-p) 75Ω (Unbalanced) |                      |
| Resolution (H)               |       | More than 570TVL (Center)                    |                      |
| Minimum illumination         |       | 0.003 lx F1.4 (AGC HIGH=32dB, Shutter=OFF)   |                      |
| S/N                          |       | More than 50dB (AGC OFF=10dB, γ=1.0)         |                      |
| Function settings            |       | DIP Switch                                   |                      |
| AE mode                      | Fixed | 1/60, 1/100 sec.                             | 1/50, 1/120 sec.     |
|                              | EI    | 1/60 - 1/100000 sec.                         | 1/50 - 1/100000 sec. |
| AGC                          | ON    | 5 - 20dB (LOW), 5 - 32dB (HIGH)              |                      |
|                              | OFF   | 10dB   |                      |
| MGC                          |       | -  |                      |
| Gamma characteristics        |       | γ≒0.45, 1.0                                  |                      |
| Video level                  |       | 100IRE                                       |                      |
| Noise reduction              |       | -  |                      |
| Wide dynamic range           |       | -  |                      |
| Lens iris                    |       | Video (Watec original arrangement)           |                      |
| Back light compensation      |       | BLC  |                      |
| White blemish correction     |       | -  |                      |
| Sharpness                    |       | -  |                      |
| Defog                        |       | -  |                      |
| Digital zoom                 |       | -  |                      |
| Privacy mask                 |       | -  |                      |
| Mirror image                 |       | -  |                      |
| Freeze                       |       | -  |                      |
| Motion detection             |       | -  |                      |
| Neg.image                    |       | -  |                      |
| Interface                    |       | RCA (Composite Video), Power in, Auto iris   |                      |
| Power supply                 |       | DC+12V±10%                                   |                      |
| Power consumption            |       | 1.74W (145mA)                                |                      |
| Operating temperature        |       | -10 - +40°C                                  |                      |
| Storage temperature          |       | -30 - +70°C                                  |                      |
| Operating / Storage humidity |       | 95% RH or less (Without condensation)        |                      |
| Lens mount                   |       | CS mount                                     |                      |
| Weight                       |       | Approx. 86g                                  |                      |
| Accessories                  |       | WPDC12 (DC plug), AIC (Iris plug)            |                      |

Options

CS-mount lenses

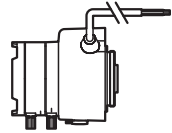

HG2Z4516AFCS-2

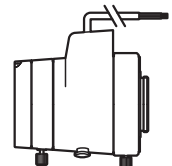

HG3Z1014AFCS

※ Iris plug (AIC) included to the product

Miniature lenses / Mount adaptors



0814BC-12



22PMA-M12-125



3745B-13P



22PMA-M13-040

**WAT-902B**

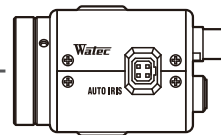

VIDEO OUT (RCA)



POWER IN (DC12V)

Cables



3C2V (BNC/RCA)

BNC



3C2V (RCA/RCA)

RCA



※Not in our lineup

Power supply adaptors



SWI12-12-N-P5

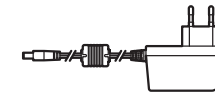

SWI12-12-E-P5

Stands



MS50



WH-31

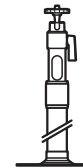

WH-11

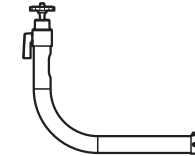

WH-21

C-mount adaptor



30CMA-R

C-mount Lenses

※Not in our lineup

Water resistant camera housing / Mounting brackets



VCHO-15S

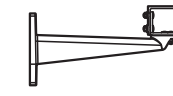

WH-6N

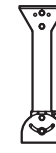

PTP-300